

Installation instructions apply to “UJ” series cables and connectors such as “SR-5W-1-250-U” designating “Unjacketed” cable. Non-jacketed cable should only be used on residential, indoor pipe-protection projects. Damage to, or improper installation, use and/or maintenance of electrical heating cable can result in fire, electrical shock, and/or freezing of pipe.

Applies to:

Cables

SKU	Description
SR-K6UJ	6' KIT
SR-K12UJ	12' KIT
SR-K18UJ	18' KIT
SR-K24UJ	24' KIT
SR-5W-1-250-U	250' SPOOL

Accessories

SKU	Description
SR-HTMK	Connection and end cap
SR-TAPE-UJ	Application tape
SR-PLUG	ON/OFF Plug

Only use this product on water supply and drain pipes. Always read and comply with the following important safety instructions. Failure to comply can result in serious injury or death from fire or electrical shock.

IMPORTANT SAFETY INSTRUCTIONS

- HEATING CABLES MUST BE INSTALLED IN COMPLIANCE WITH ALL NATIONAL, STATE AND LOCAL CODES. CHECK WITH YOUR LOCAL ELECTRICAL INSPECTOR FOR SPECIFIC DETAILS.
- ALWAYS EXERCISE PROPER CARE AND CAUTION DURING INSTALLATION AND USE OF THE UJ PIPE HEATING SYSTEM. CAREFULLY FOLLOW AND UNDERSTAND THE INSTRUCTIONS AND WARNINGS PROVIDED FOR YOUR SAFETY.
- THE UJ CABLE CONNECTOR HOUSING AND FIBERGLASS THERMAL INSULATION WITH VAPOR SEAL MUST BE KEPT DRY AND WATERPROOF TO AVOID POSSIBLE ELECTRICAL SHOCK OR FIRE.
- ONLY USE THE UJ SYSTEM ON METAL AND PLASTIC DOMESTIC WATER PIPES.
- NEVER EXPOSE UJ CABLE TO TEMPERATURES ABOVE 150°F (66°C), THIS WILL SHORTEN THE LIFE OF THE CABLE. ALTERNATIVELY, CONSIDER WARMUP SR-K JACKETED KIT SERIES FOR HIGHER TEMPERATURE ALLOWANCE.
- TO AVOID SHORT CIRCUITS, NEVER TWIST THE WIRES INSIDE THE UJ CABLE TOGETHER OR ALLOW THEM TO TOUCH EACH OTHER OR THE OUTER BRAID.
- ALWAYS REMOVE OLD HEATING TAPES OR INSULATION.
- ALWAYS KEEP CABLE ENDS CLEAN AND DRY.
- SEAL THE CABLE ONLY WITH THE END SEAL PROVIDED.
- ONLY CUT THE UJ CABLE JACKET AT THE ENDS WHEN ATTACHING THE FUSED PLUG AND END SEAL (SR-HTMK).
- BEFORE INSTALLING THE UJ CABLE, FILE AND REMOVE FROM THE PIPE ALL SHARP EDGES WHICH MIGHT DAMAGE THE CABLE. THE CABLE MUST TOUCH ONLY SMOOTH NON-ABRASIVE PIPE SURFACES.
- ALWAYS PROTECT THE COMPLETE SYSTEM FROM DAMAGE BY ANIMALS OR IMPACT.
- ONLY USE 1/2" OR 1" VINYL OR FIBERGLASS TAPE TO ATTACH CABLE TO PIPE (SR-TAPE-UJ).
- INSPECT THE UJ CABLE FOR DAMAGE EACH TIME YOU PLUG IT IN. IF LEFT PLUGGED IN ALL YEAR, INSPECT IT AT LEAST ONCE A YEAR OR ANY TIME YOU HAVE REASON TO SUSPECT DAMAGE. USE SR-PLUG FOR INCREASED LIFESPAN AND PERFORMANCE.
- IF YOU SEE A CUT, NICK OR WORN SPOT ON THE CABLE, IMMEDIATELY DISCONNECT THE SYSTEM AND REPLACE IT. THERE ARE NO SERVICEABLE PARTS IN THE UJ CABLE SYSTEM.
- ONLY CONNECT THE PLUG TO A RECEPTACLE INSTALLED ACCORDING TO THE NATIONAL ELECTRICAL CODE (OR CEC) AND PROTECTED FROM RAIN AND WATER.
- ALWAYS USE A GROUND FAULT PROTECTION DEVICE (GFCI) TO REDUCE THE DANGER OF FIRE FROM A DAMAGED OR IMPROPERLY INSTALLED HEATING CABLE. ELECTRICAL FAULT CURRENTS CAUSED BY DAMAGED OR IMPROPERLY INSTALLED CABLE MAY NOT BE LARGE ENOUGH TO TRIP A CONVENTIONAL CIRCUIT BREAKER. IF IN DOUBT, USE WARMUP'S CRDS-GFI-15 CONNECTOR.
- IN MOBILE HOME APPLICATIONS, ONLY CONNECT THE PLUG TO AN ELECTRICAL OUTLET UNDERNEATH THE MOBILE HOME. THE OUTLET MUST BE IN AN UNEXPOSED, DRY LOCATION BECAUSE THE PLUG IS NOT WEATHERPROOF. NEVER USE AN EXTENSION CORD.

- NEVER ALTER THE PLUG IN ANY WAY. ONLY USE THE FUSED PLUG KIT FOR MAKING CONNECTIONS.
- NEVER CUT, NICK, OR ALLOW THE PLASTIC JACKET OF THE UJ CABLE TO BE WORN DOWN. THE BRAID MUST REMAIN INTACT.
- NEVER INSTALL THE CABLE WHERE IT MIGHT BE HIT, CUT OR DAMAGED BY RUBBING AGAINST ROUGH SURFACES.
- NEVER USE METAL CLAMPS, OR OTHER SHARP DEVICES THAT MIGHT CUT THE CABLE.
- NEVER SPLICE OR REPAIR A DAMAGED CABLE.
- ALWAYS REPLACE A DAMAGED CABLE WITH A NEW ONE.
- ALWAYS REPLACE ANY DAMAGED INSULATION AND WATERPROOF COVERING AFTER EACH INSPECTION OF THE CABLE.
- NEVER INSTALL OR USE UJ CABLE WHERE FLAMMABLE MATERIALS, LIQUIDS OR VAPORS MAY BE PRESENT. IF THE CABLE IS CUT WHILE THE SYSTEM IS CONNECTED, THE RISK OF FIRE IS INCREASED.
- DO NOT INSTALL HEATING CABLE WHEN TEMPERATURE IS BELOW -20°F (-29°C)

ADDITIONAL TOOLS AND MATERIALS REQUIRED

- Application tape (Warmup's SR-TAPE-UJ) or high-quality electrician's tape such as Scotch 44 or 33.
- 1/2" fiberglass pipe insulation with vapor seal.
- Wire cutters, screwdriver and measuring tape.

HOW TO DETERMINE THE LENGTH OF CABLE NEEDED

Collect the following information:

Measure/Count:	Example
Pipe Diameter	1 1/2"
Pipe Length	12 ft
Lowest expected Air Temperature	-20 F / -29 C
Number of valves/spigots	1

LENGTH SELECTION CHARTS

Choose either Chart #1 or Chart #2 for your type of pipe (plastic or metal). Read down to find your pipe diameter, then read across to the box below your lowest expected temperature.

PLASTIC/PVC PIPES (based on 1/2" insulation added)

Multiply pipe length with below multipliers based on pipe diameter and lowest expected temperature. This will give you the total length of cable required. Spiral cable evenly along pipe

Pipe Diam.	Lowest Expected Temperature		
	+20F/-7C	0F/-18C	-20F/-29C
1/2"	1	1.5	1.5
3/4"	1	1.1	1.7
1"	1	1.3	2
1 1/4"	1	1.6	2.3
1 1/2"	1	1.8	2.5
2"	1	2.1	3

METAL PIPES (based on 1/2" insulation added)

Multiply pipe length with below multipliers based on pipe diameter and lowest expected temperature. This will give you the total length of cable required. Spiral cable evenly along pipe.

Pipe Diam.	Lowest Expected Temperature		
	+20F/-7C	0F/-18C	-20F/-29C
1/2"	1	1	1
3/4"	1	1	1.1
1"	1	1	1.3
1 1/4"	1	1.1	1.6
1 1/2"	1	1.2	1.8
2"	1	1.5	2.2

ADD LENGTH FOR SPIGOT + VALVES

Add one extra foot for each valve located in your line. Maximum cable length is 75 feet. For cable lengths longer than 75 feet, use two cables.

HOW TO INSTALL THE CABLE ON THE PIPE

Securing the cable to the pipe:

Starting at the plug end, either spiral wrap or straight trace the cable on the pipe, as indicated in the Length Selection Chart. Mount the plug (SR-HTMK) on the pipe with plastic tie wraps or Warmup Tape (SR-TAPE-UJ).

Spiral wrapping method

Spiral wrap the cable around the outside of the pipe. Allow an even distance between wraps to avoid excessive overlapping. Secure cable with tape every few turns. Mark the pipe at the required distance between wraps before attaching the cable to the pipe.

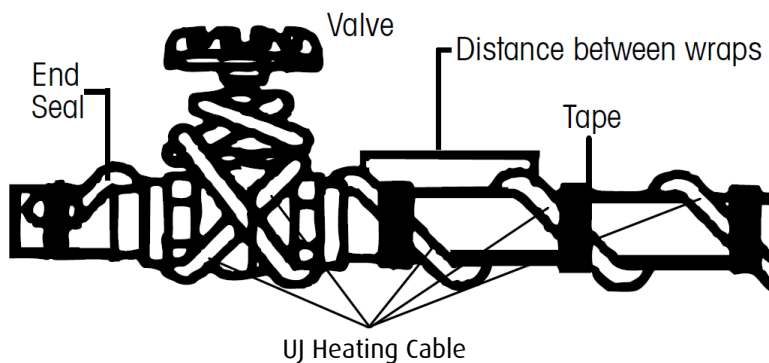

Straight tracing method

Run the cable in a straight line parallel to and approximately 1/3 of the way from the BOTTOM of the pipe (at "4 o'clock" or "8 o'clock").

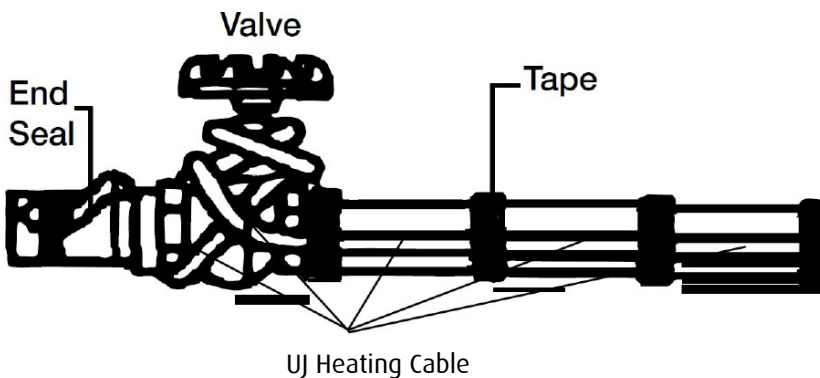

Additional notes and figures:

- Provide extra heat at valves and spigots by wrapping each with one additional foot of cable, overlapping as required.

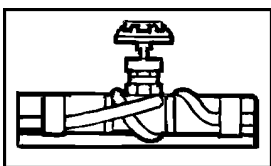

- Fasten the cable to the pipe at 6' intervals with tape. If excess cable remains at the end of the pipe, double it back along the pipe where the insulation will completely cover it.

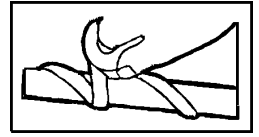

Terminating the Cable with End Seal (full video available on Warmup Inc Youtube channel)

When purchasing from a spool, ensure you have an SR-HTMK connection kit with end seal (included).
When using SR-UJ kits, you may re-terminate the cable with the provided extra End Seal.



Watch video

- Terminate the cable where required, then proceed to peel off 1" of the ground braid. Use a flat screwdriver or knife, then twist the excess braid together and away from the final 1 inch of cable. Wrap the twisted ground around the cable and tape.
- On the exposed final inch of cable, apply the end seal by sleeving the cable into the **gel-filled cap**. Some sealant may ooze out, do not wipe it off. Do not twist or remove after application. Let sealant cure to complete the termination.
- Tape end seal to pipe. If the pipe is vertical, point the end seal "up" to reduce the risk of water leaking into the end seal over time.
- In a mobile crock or standpipe, never install the UJ Cable end seal where it would normally be submerged.

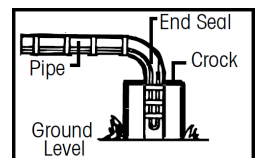
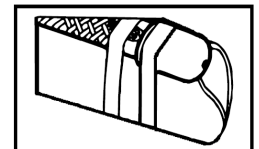

APPLYING INSULATION

Thermal insulation protects the UJ Cable and helps prevent pipe from freezing by keeping the heat around the pipe.

BEFORE insulating, MAKE SURE that there is NO UJ Cable damage (such as nicks or cuts) and that the braid is intact. Inspect visually and test insulation resistance with Megger.

Cover the pipe, cable, connections, valves and spigots with 1/2" clean, dry fiber glass insulation. Do not leave any cable exposed, except for the Power Indicator light of the SR-HTMK plug connector. Apply provided labels on outer insulation as needed along the pipe.



CONNECTING THE SR-HTMK

Only applies to cable purchased from spools. Warmup SR-UJ kits are pre-terminated. Check the SR-HTMK by plugging it in. Your power indicator light should turn on. Unplug the SR-HTMK and remove the cover



Loosen assembly screws without fully removing them. Slide the cable into SR-HTMK by letting the ground braid slide back. DO NOT ALLOW ground braid to make contact with the assembly screw fixture as it would power the ground braid and risk causing fire and/or electrical shock.

Fully slide in the unbraided part of the cable to the end of the SR-HTMK and tighten the assembly screws. Make sure the ground cable is in contact with the ground strip. This completes the grounding of the system. Close the cover and tighten cover screws.

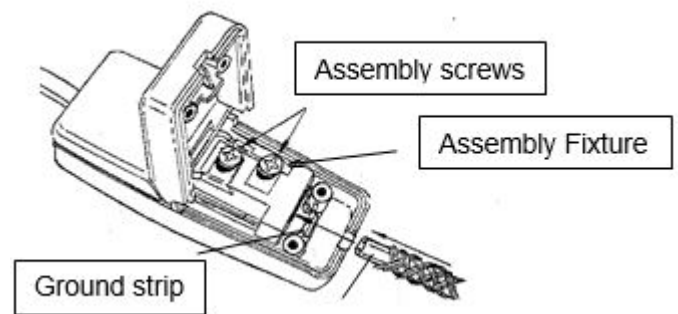

Watch video

OPERATION AND MAINTENANCE OF YOUR UJ SYSTEM

Once installation is complete, plug the cable into a 120 volt outlet. The UJ cable should feel warm to the touch almost instantly.

Troubleshooting

Check the power light on the plug to see if the cable is energized. If the power light is off, unplug the UJ Cable, and check for and correct the following:

- Do you have power going to your electrical outlet?
- Is the SR-HTMK wired correctly?
- Is your insulation dry on the inside?
- Have you installed the correct amount of cable (not exceeding 75ft)?

WARNING

If any part of the UJ Cable System is damaged, the whole system is damaged. Never attempt to repair any part of the cable system, including a blown fused plug. Always replace a damaged system with a new system.

SEASONAL INSPECTION

While the UJ system can be left plugged in all year, you will save energy if you unplug it during non-freezing weather. Warmup also recommends the use of the SR-PLUG. In any case, each time you plug it in, or at least once a year if you leave the system plugged in, or any time you have reason to suspect damage, make the following inspection:

- Check the entire UJ system for signs of damage. Note this may be evidenced by damaged or discolored insulation.
- Inspect any exposed portion of the cable for evidence of cuts, nicks, abrasions, gnawing by animals, or other physical damage.
- If there is damage, immediately replace the damaged cable system.

LIMITED WARRANTY AND LIABILITY

Warmup warrants that if there are any defects in material or workmanship in this product during the first twelve (12) months after the date of its purchase, we will replace the product with an equivalent model, not including any labor or other installation costs.

Our obligation to replace the product as described above is conditioned upon (a) the installation of the product conforms to the specifications set forth in our installation instructions and (b) the product not having been damaged by unrelated mechanical or electrical activities.

Product replacement as described above shall be your sole and exclusive remedy for a breach of this warranty. This limited warranty does not cover any service costs relating to repair or replacement.

We shall not be liable for any incidental, special or consequential damages as a result of any breach of this warranty or otherwise, whether or not caused by negligence. Some states do not allow the exclusion or limitation of incidental or consequential damages, so the above limitation or exclusion may not apply to you.

The warranty above is exclusive and makes no other warranties with respect to description or quality of the product. No affirmation of fact or promise made by us, by words or action, shall constitute a warranty. If any model or sample was shown to you, the model or sample was used merely to illustrate the general type and quality of the goods and not to represent that the goods would necessarily be of that type or nature. No agent, employee or representative of ours has authority to bind us to any affirmation, representation or warranty concerning the goods sold unless such affirmation, representation or warranty is specifically incorporated by written agreement.

Any implied warranty of merchantability or fitness for particular purpose that may arise in connection with the sale of this product shall be limited in duration to twelve (12) months from the date of purchase. We disclaim all other implied warranties, unless we are prohibited by law from doing so, in which case all such implied warranties shall expire at the earliest time permitted by applicable law. Some states do not allow limitations on how long an implied warranty lasts, so the above limitation may not apply to you. This warranty gives you specific legal rights, and you may also have other rights which vary from state to state or province to province.

To obtain a replacement under this warranty any inoperative product or component must be returned, with proof of purchase, to Warmup at the addresses noted herein. Buyer is responsible for all costs incurred in removal and re-installation of product and must pre-pay shipment to factory or point of purchase.

The Listing for the UJ Heating Cable system is limited to mobile home pipe heating and the limitations below must be observed:

- The UJ System is not for outdoor use other than the underside of a home.
- It must never be connected to an exposed or outdoor electrical outlet other than one located under a mobile home.
- Never use an extension cord to reach the electrical outlet.
- The National Electrical Code requires that a heating cable system electrical outlet located on the underside of a mobile home must be within 2 feet of the cold water inlet.

